



PIPE TOOLS & VISES  
SINCE 1896

# PLAS Hand-over-Hand Rotary™ Cutters (PLASOH & PLASOHPE)

## Replacement Parts

#04463 and #04464

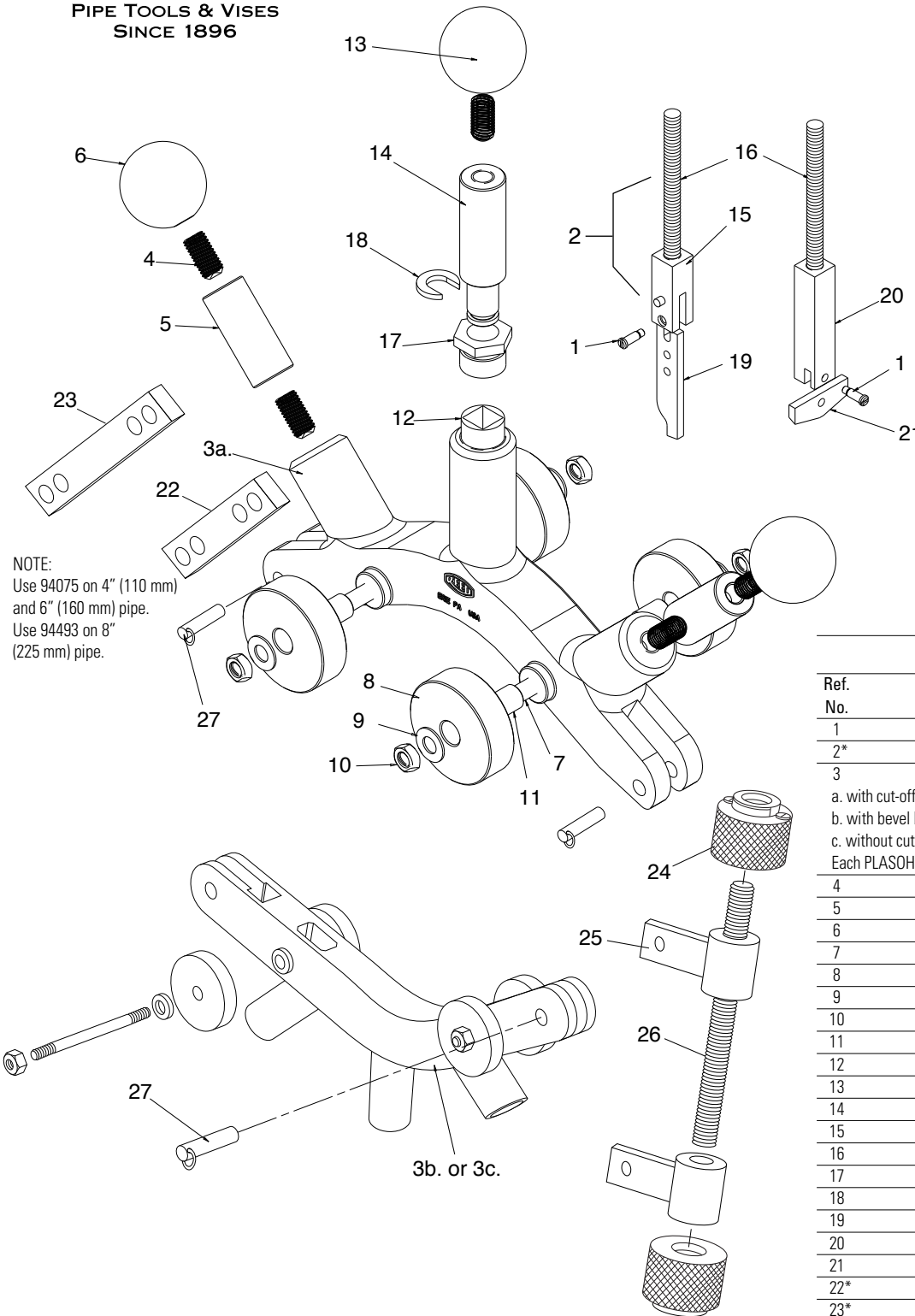

NOTE:  
Use 94075 on 4" (110 mm)  
and 6" (160 mm) pipe.  
Use 94493 on 8"  
(225 mm) pipe.

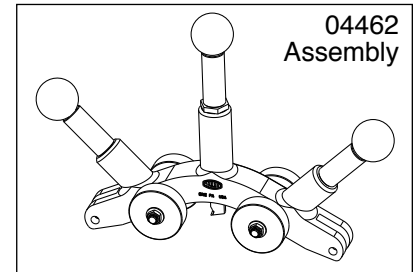

04462  
Assembly

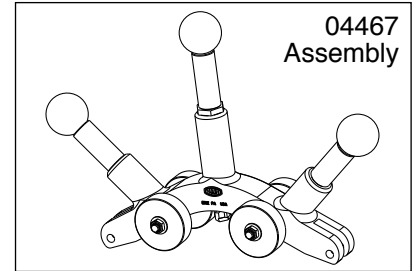

04467  
Assembly

## Parts List

Ref. No.	Description	Item Code	Qty
1	Threaded Wheel Pin	93428	1
2*	Cut-off Blade Holder Assembly	94466	1
3	E Section Variations		
a.	with cut-off blade for PLASOH/PLASOHPE #04463 or #04464:	04462	1
b.	with bevel blade for PLASOH #04463:	04467	1
c.	without cutter for PLASOHPE #04464:	04462N	1
Each PLASOH has two yokes that differ slightly from one another.			
4	1/2-13 X 1 Set Screw	34913	5
5	Handle	94474	2
6	Black Ball Knob	40050	2
7	Roller Pin	97536	2
8	2.5" Roller (PVC)	97570	4
9	3/8 Washer	30011	4
10	3/8-16 Hex Nut	30143	4
11	Roller Bushing	97537	4
12	3 1/4 Liner	40158	1
13	Red Ball Knob	40051	1
14	Extended Threaded Bushing	94478	1
15	Cutoff Holder	94481	1
16	Threaded Rod	94484	1
17	Threaded Liner	94488	1
18	Retainer	94489	1
19	No 14 Cutoff For PVC	94537	1
20	Bevel Blade Holder	94492	1
21	No 415 Bevel Blade	94473	1
22*	Pivot Link	94075	1
23*	Long Pivot Link	94493	1
24	Adjusting Nut Assembly	94468	4
25	Adjusting Pivot Assembly	94085	2
26	Main Screw	94088	1
27	Quick Pin	94477	4

\*94466 contains Roll Pin 30191, 94481 & 94484.

Reed Manufacturing Company  
1425 West 8th Street  
Erie, PA 16502 USA

**QUALITY**  
& Service  
that Last a Lifetime

Phone: 800-666-3691 or 814-452-3691  
Fax: 800-456-1697 or 814-455-1697  
www.reedmfgco.com

RP-0516-119